

**THIS MANUAL IS PART OF THE PRODUCT. READ IT CAREFULLY IN ORDER TO USE AND MAINTAIN THE EQUIPMENT CORRECTLY.
IT IS IMPORTANT TO KEEP IT FOR FUTURE TROUBLESHOOTING AND REFERENCE.**

WARNING

This machine is intended for use in domestic and similar applications such as kitchen areas for staff in stores, offices and other work environments, rural accommodation and hotels, motels and other residential-type environments, bed and breakfast environments, catering services and similar non-retail applications.

The installation of this equipment should be done by the Technical Assistance Service department.

The socket should always be placed on an accessible location.

When positioning the appliance, ensure that the power cable is not trapped or damaged.

Do not place multiple portable socket outlets or portable power sources in the rear of the appliance

ALWAYS disconnect the power supply from the machine BEFORE any cleaning or maintenance service.

Any change needed on the electrical installation for the appropriate connection of the machine, should be exclusively performed by qualified and certified professional personnel only.

Any use by the ice maker not intended to produce ice, using drinking water, is considered inappropriate.

It is extremely dangerous to modify or intend to modify this machine and shall make any type warranty void.

This device is not intended for use by persons (including children) whose physical, sensory or mental capacities are limited, or who lack sufficient experience or knowledge, unless they are acting under the supervision of or have received instruction regarding proper use of the device from a person responsible for their safety. Children should be supervised to ensure they do not play with the device.

Children should be monitored to assure that they should not play near the equipment.

This machine is not intended to be used outdoors nor exposed to the rain. Connect the equipment to the drinking water network. See section 3 of this manual.

The machine should be connected using the power cable supplied with the equipment. The connection is not intended for fixed cabling.

This appliance uses flammable refrigerant (propane), stored in the unit's refrigeration circuit.

For this reason, the following precautions should be followed:

- Maintain without obstruction the openings intended for ventilation of the enclosure of the appliance or of the recess.
- Do not use mechanical devices or other means to accelerate defrosting, using only those recommended by the manufacturer.
- Do not damage the refrigeration circuit.
- Do not use electrical devices inside the food compartments unless they have been approved by the manufacturer.
- Explosive substances, such as aerosols with flammable propellant, should not be stored in this machine.

In case of refrigerant leakage:

- Do not generate any flame in the vicinity of the appliance.
- Do not operate on/off switches or plug/unplug power cables in the vicinity of the appliance.
- Do not use a direct flame.
- Ventilate the area around the appliance immediately by opening doors and windows.
- Notify an authorized service technician.

IT IS MANDATORY TO GROUND THE EQUIPMENT

To avoid possible discharges on individuals or damages to the equipment, the machine should be grounded pursuant local and/or national regulations as the case may be.

THE MANUFACTURER SHALL BE HELD HARMLESS IN CASE OF DAMAGES ARISING DUE TO THE LACK OF THE GROUND INSTALLATION.

SEE SECTION 4 OF THIS MANUAL

In order to assure the proper operation and efficiency of this equipment, it is of paramount importance to follow the recommendations of the manufacturer, **SPECIALY THOSE RELATED TO CLEANING AND MAINTENANCE OPERATIONS**, which should be performed mostly by qualified personnel only.

CAUTION:

Do not try to perform repairs. The intervention of non-qualified personnel, besides of being dangerous, could result in serious malfunctioning. In case of damages, contact your distributor. We recommend to always use original replacement and spare parts.

Perform all discharge and recovery of materials or waste according the national regulations in force.

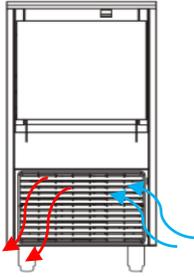

In R290 units under the counter, the passage of air can be in front. The unit can work recessed with a loss of production.

THREAD THE SUPPORT LEGS TO THE BASE OF THE MACHINE ON THE HOUSING SET TO SUCH END AND REGULATE THE HEIGHT AS TO HAVE THE EQUIPMENT PERFECTLY LEVELLED.

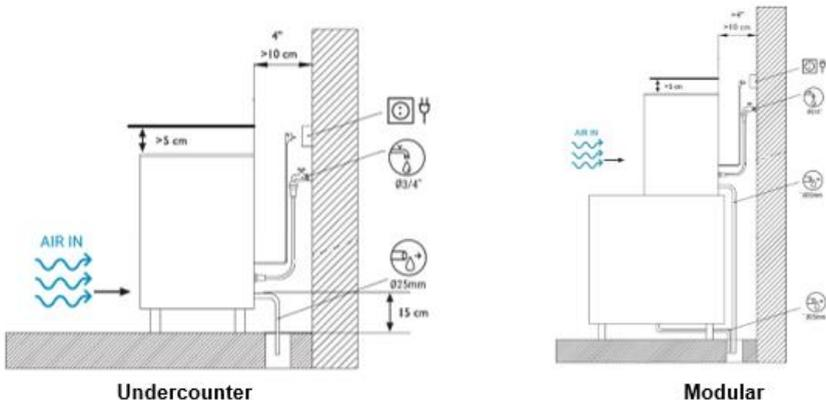

Undercounter

Modular



1. WATER AND DRAINAGE

Water quality has a remarkable influence on the appearance, hardness and flavor of the ice as well as, on the machines condensed by water, on the life of the condenser.

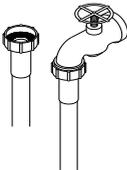

2. CONNECTIONS TO THE WATER NETWORK

Use a flexible pipe (1.3 m – 4.27 feet length) with the two filter joints supplied with the machine. Arrange the necessary appliances according to regulations or current norms to prevent water return to the network. Pressure should be established between 0.1 MPa and 0.6 MPa (1-6 BAR). If pressures overpass such values, install the necessary

corrective devices.

3.CONNECTION TO DRAINAGE

Drainage should be located lower to the machine level, at 150 mm (5.91 inches) minimum. It is convenient that the drainage pipe is of 30 mm (1.18 in) of interior diameter and with a minimum gradient of 3 cm (1.18 in) per meter (see figure).

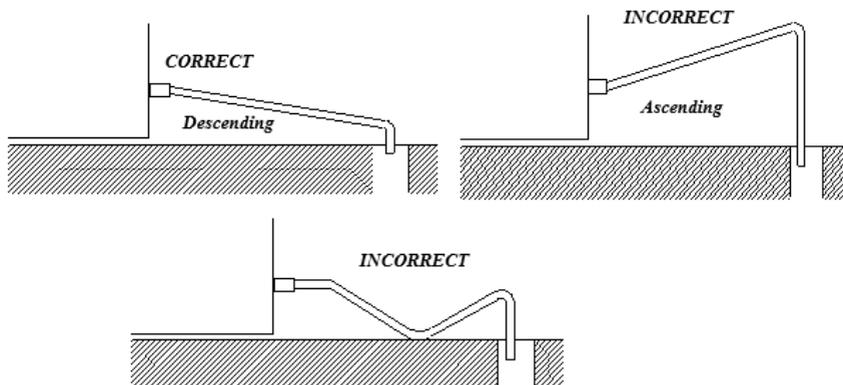

4. ELECTRICAL CONNECTION

IT IS MANDATORY TO GROUND THE EQUIPMENT

To avoid possible discharges on individuals or damages to the equipment, the machine should be grounded pursuant local and/or national regulations as the case may be.

THE MANUFACTURER SHALL BE HELD HARMLESS IN CASE OF DAMAGES ARISING DUE TO THE LACK OF THE GROUND INSTALLATION.

- The positioning of the device must ensure that the power connection is not damaged or pinched.
- Do not install multiple portable power outlet strips or other portable power supplies in back of the device.
-

The machine is supplied with a 1.5 m (4.92 feet) cable of length. In case the supply cable is damaged, it should be replaced by a cable of special assembly to be furnished by the manufacturer or post-sale service. Such replacement should be performed by qualified technical service only.

The machine should be placed in such a way as to allow a minimum space between the back and the wall to allow an easy access and without risks to the cable jack. Safeguard the base of the jack.

It is advisable to install a power switch and the appropriate electrical safety devices in accordance with local and/or national regulations in each case.

Voltage and tension are indicated in the nameplate and on the technical specifications of this manual. Variation on voltage above the 10% stated on the nameplate could result on damages or prevent the machine start-up.

5. INSTALLATION OF MODULAR EQUIPMENT ON TANKS OR SILOS.

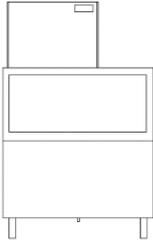

Modular machines must be installed on tanks or silos, following the instructions in this manual.
The strength and stability of the container-machine/s assembly must be checked, as well as the fixing of the elements.

6. ASSEMBLY OF THE DISPERSION CONE (MODULAR MODELS)

This accessory distributes the ice in the silos, and prevents it from caking under the outlet

pipe.

By varying its position, the ice can be guided in any direction. (Not included with the machine).

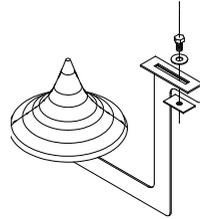

7. WATER LEVEL

The function of the water level is to maintain the necessary flow in the evaporator and, with the included micro magnet, stop the operation of the machine until the water reaches the bucket again.

The optimum level is at the horizontal line indicated in the figure, and its regulation is done following the instructions of the same.

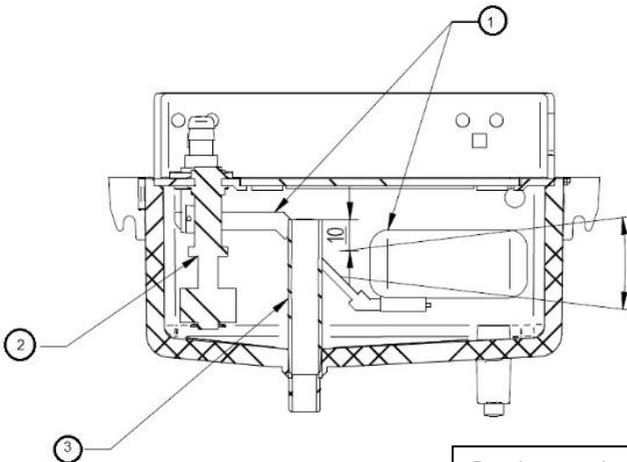

- 1 – Float
- 2 – Probe
- 3 – Safety overflow

Bend up to raise the level and down to lower it.
(Take only by the metal arm
NEVER BY THE FLOAT)

START-UP

Previous Checkup

- a) Is the machine leveled?
- b) Voltage and frequency are the same as those on the nameplate?
- c) Are the discharges connected and operating?
- d) ** If air condensed: Is the air circulation and its temperature appropriate?

	ROOM	WATER
MAXIMUM	43°C (109.40°F)	35°C (95°F)
MINIMUM	5°C (43°F)	5°C (35°F)

** Is water pressure appropriate?

MINIMUM	0.1 MPa (1 Bar)
MAXIMUM	0.6 MPa (6 Bar)

NOTE: In case input water pressure is higher than 0,6 MPa (6 Bar) install a pressure reducer. THE FAUCET CONNECTION PRESSURE SHOULD NEVER BE REDUCED.

START-UP

Once the installation instructions are followed (ventilation, site conditions, temperatures, water quality, etc.), proceed as follows:

1. In modular models, remove the top cover to access the installation kit (filters, connection hoses, etc.)
2. In compact models, open the tank door to access the installation kit.
3. Connect the water hose of the machine to the stopcock.
4. Open the water stopcock. Check that there are no leaks.
5. Connect the machine to the electricity supply and turn on the main switch located on the front.
6. For the three-phase machine, if the sequence is not correct the red pilot-light will turn on and it is necessary to change the connection sequence.
7. Check that there is no friction or vibrating element.
8. After 10 minutes of the timer installed in the electrical panel, the machine will be put into operation. (This delay will happen each time the machine is stopped).
9. In modular models (mainly in three-phase equipment), with the upper cover removed, check that the motor rotation is in the correct direction.

CAUTION:

INSTRUCT THE USER ABOUT MAINTENANCE, INFORMING THAT MAINTENANCE AND CLEANING OPERATION AS WELL AS DAMAGES DUE TO THE LACK OF SUCH OPERATIONS: ARE NOT INCLUDED ON THE WARRANTY.

MAINTENANCE AND CLEANING INSTRUCTIONS

CAUTION: Maintenance and cleaning operations and damages as the lack of those activities: Are not included on the warranty.

If a good maintenance is performed, the machine will continue producing a good quality ice and will be free of damages.

Maintenance and cleaning intervals will depend on the conditions of the location and water quality.

CAUTION: At least, one revision and cleaning should be performed every six months. On dusty environments, it might be necessary to clean the condenser on a monthly basis.

MAINTENANCE AND CLEANING PROCEDURES

NOTE: For cleaning and maintenance: ensure that the machine is disconnected from electrical supply, except when cleaning the production bin.

1. Water condenser

To be carried out by a qualified technician. Included in the technical manual.

2. Air Condenser

- 1) Disconnect the machine.
- 2) Disconnect the water inlet or close the faucet.
- 3) Clean the louvered area with the help of an aspirator with a brush, non-metallic brush or low-pressure air.

3. Cleaning the ice bin and exterior.

- 1) Disconnect the machine, switch off the water supply and empty the ice bin.
- 2) Clean with a soft kitchen cloth, plenty of water and a mild detergent.

4. Collectors and Nozzles cleaning

To be carried out by a qualified technician. Included in the technical manual.

5. Cleaning of the Inlet filters

They are easily obstructed during the first days of operation, MAINLY WITH NEW PIPING INSTALLATIONS.

Loose the hose and clean it under water.

6. Water Leak Control

When working on the machine, always check the water connections, status of the clamps and hoses with the purpose of avoiding leakages and prevent damages or floods. Loosen the hose and clean under running water.

WATER QUALITY & WARRANTY

In areas with water hardness outside the range of 15°F to 40°F, water filters or descaling systems are required to protect the ice machine. The Warranty will cease to exist if the mentioned protective measures haven't been applied where needed.